

Optimize your plant
operations performance

CONTROL
ENGINEERING

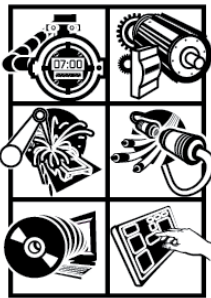

2019
ENGINEERS'
CHOICE
AWARDS

WINNER

of the
Process Control Systems
Category



DeltaV™ Distributed Control System
Eliminate operational complexity and project
risk with an easy and flexible distributed control system.



You're expected to do more with less, while dealing with increasing operational complexities and project risks.

Process automation is highly complex. You're being asked to improve process performance with fewer engineers, increase reliability with lower maintenance budgets, and guarantee quality during changing conditions.

It's also vital in delivering the results your organization depends on. Automation complexity, equipment and experience costs, and late changes add to the anxiety.

"The automation schedule is extremely important because it's one of the last things started up."

– Blue Canyon Partners interviews with global EPC, Oil & Gas, HPI leaders



"There is a significant amount of cost associated with traditional marshalling methods, which can also limit the changes possible in the engineering and design of the system."

– Larry O'Brien, research director at ARC Advisory Group



"The complexity of projects is increasing daily – technically, geopolitically, and commercially with partner complexities."

– Blue Canyon Partners interviews with global EPC, Oil & Gas, HPI leaders



"ARC (Advisory Group) estimates the global process industries lose \$20 billion, or 5% of annual production, as the result of unscheduled downtime. Drilling down into this number, we estimate that nearly 80% of these losses are preventable."

– ARC Advisory Group, Paula Hollywood, "Passing the Insurance Acid Test with APM"





What if you could improve day-to-day operations, receive data that your people can understand easily, get superior intelligent control applications, and remain confident with the reliability of your operation?

Improve plant performance with the DeltaV distributed control system.

The DeltaV distributed control system (DCS) improves your operations by harnessing today's predictive technologies in an easy, intuitive, and interoperable way to connect your people, processes, and production. The DeltaV DCS provides systems and tools to provide the decision integrity to run your operation at its full potential. Emerson designed the DeltaV DCS to simplify tasks throughout the lifetime of your facility.

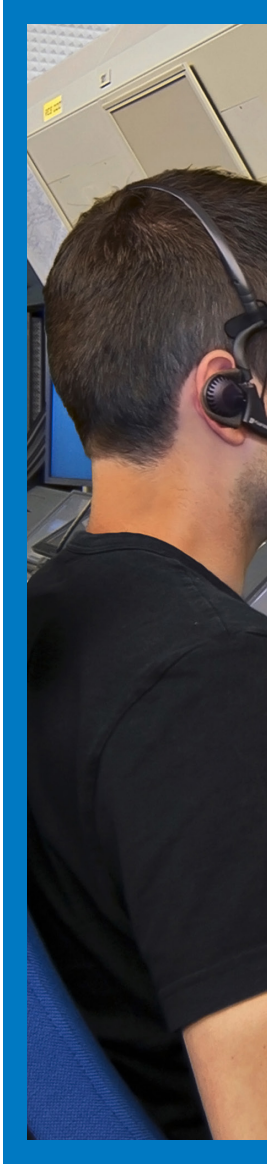

**CONTROL
ENGINEERING**
2019
ENGINEERS'
CHOICE
AWARDS

WINNER

of the
Process Control Systems
Category



2019 exida
SAFETY & CYBER AWARDS



Improve every aspect of your operation with an easy-to-use control system.

Founded on ease-of-use, the DeltaV system improves not only day-to-day operations, but also engineering for start-ups and changeovers.

Get simplified data in a quick and efficient manner with our intuitive system.

Through its intuitive design, the DeltaV system guides personnel to find solutions quickly.

Remain confident knowing your DCS is ISASecure certified.

DeltaV robust hardware and extensive software testing deliver the reliability you need to attend to process optimization.

Get the most of your plant with superior advanced control applications.

Take advantage of superior control and a full suite of embedded advanced control applications that enable you to get the most from your plant.

Get answers to your difficult tasks with an easy-to-use system.



The DeltaV system — with its intuitive interfaces and task simplification — guides operators and engineers alike in addressing difficult problems and finding efficient solutions.

Innovative DeltaV technologies and methods combine to streamline complicated tasks and reduce the overall workload.

Eliminate work and reduce complexity

The DeltaV DCS employs a single-environment configuration for alarms, batch, advanced control, safety, and historians. Out-of-the-box templates and modular configuration libraries require little specialized knowledge to operate, resulting in easy configuration and reduced testing.

Improve productivity through easily understood interfaces

Human Centered Design (HCD) is central to Emerson's development and design of operator screens. Quickly customize powerful operator interfaces and quickly gain access to the most important information in an easy-to-use graphic solution.

Accommodate late changes with Electronic Marshalling

DeltaV Electronic Marshalling technology lets you land field cabling where you need it, regardless of signal type or control strategies. With Electronic Marshalling you can decouple the process design from the I/O infrastructure design to further accommodate changes.

Make intelligent decisions quicker that enhance your performance.

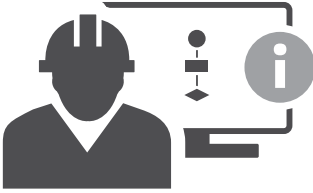

The DeltaV intuitive environment promotes a thorough understanding of situations and drives appropriate actions. The system allows your people to seek positive solutions quickly, reduce the pressure of compressed timelines, and the system's predictive intelligence keeps your people safe when hazardous situations may occur.

Improve productivity through simple architectures

The DeltaV DCS is an intuitive operating environment. System architecture, hardware, software, and interfaces blend to create a setting where engineers and operators smoothly grasp situations and use tools to devise solutions — quickly and accurately.

Make informed decisions

Simplify device information so operators are equipped to make high-quality yet efficient decisions. DeltaV interface color themes and pattern recognition models help operators identify critical information. And built into the DeltaV Alarm Help is information from operations and maintenance experts providing knowledge, recommended actions, and probable causes.

Easily integrate data

The DeltaV DCS simplifies data integration ...

- *At the device level:* Plug-and-play capabilities exist for runtime and diagnostics in a variety of standard protocols.
- *To enterprise business systems:* Connect via industry standard OPC along with built-in Service-Oriented Architecture (SOA) web services that provide connections to Emerson's Manufacturing Execution System, Syncade™, and other systems.
- *Between the field and business systems:* Connections are made with minimal setup time. Decision makers at every level in the plant can get the critical data they need, reliably, securely, and in real time.

Remain confident with a proven and reliable system.



The DeltaV DCS helps your operation avoid unnecessary downtime that impacts your time and money.

The system identifies and realizes the condition of field equipment to enhance your operational goals. The system has equipment health alerts on the operator screen to deliver actionable real-time adjustments.

Rely on a robust system

The DeltaV DCS uses data and equipment health information from intelligent field assets to ensure the right control action is taken — preventing unwanted shutdowns if an asset fails. Critical strategies run in a rugged, high-speed, optionally redundant environment.

Depend on wireless communication

Accessible through *WirelessHART*, redundant DeltaV wireless I/O cards provide reliable communications with the self-organizing, adaptive wireless mesh networks.

Build dependability with diagnostics and testing

The use of digital intelligence and predictive diagnostics increases system availability while reducing lifecycle costs. Health diagnostics detect device failures. Device alerts promote quick action. Automatic partial stroke testing and automated proof testing streamline the process.

Accomplish an efficient operation with advanced control applications.



Get the most from your plant with the DeltaV distributed control system that delivers superior control with its embedded advanced control applications. The control power translates to fewer engineering hours and more effective operations. Using the DeltaV distributed control system, you can take advantage of superior control and have a full suite of embedded advanced control applications that enable you to get the most from your plant.

The control power that the DeltaV DCS provides translates to fewer engineering hours and more effective operations.

Strengthen control with built-in algorithms

By embedding learning algorithms directly into the DeltaV distributed control system, process knowledge can be applied to improve control overall. For example, the system can locate hidden variability and under-performing control loops. It can also monitor control performance against model-based performance benchmarks.

Save time with a built-for-purpose system

Designed for the control system engineer, advanced control applications have embedded intelligent control that can be implemented with minimal configuration and maintenance. All the technology and tools are inherently integrated with the DeltaV system. No data mapping is required. The applications are not add-ons, they are integral to the DeltaV DCS.

Optimize loops easily

DeltaV software provides the tools to monitor, analyze, and tune control loops for peak performance. Capabilities inherently part of the system instantly identify underperforming control loops, enabling you to reduce process variability and increase the efficiency of your operation.

Improve productivity with a world-class operations experience designed for today's high-performance operator requirements.

DeltaV Live is Emerson's modern, built-for-purpose operations experience that provides high performance HTML5-based displays and easy graphics configuration, all in an intuitive and customizable format with out-of-the box simplicity.



A high performance operations experience, out-of-the-box

DeltaV Live is built-for-purpose and incorporates Human-centered design (HCD) principles and support industry standards and best practices. Out of the box features such as hierarchical navigation and layouts reduce engineering effort and project costs while also providing modern, state of the art technology and flexibility for the digital workforce of today and tomorrow. Operators can also augment their environment on the fly, reducing the dependency on pre-engineered solutions.

The first DCS to natively support HTML5 graphics

DeltaV Live is the most modern DCS HMI, built on the latest graphics technologies, and the only HMI built on the W3C (World Wide Web Consortium) standards. HTML5 sets the foundation for ubiquitous use on multiple platforms like desktop, tablets, and phones – giving users the flexibility to choose the right platform or device to meet their needs. With scalable vector graphics, DeltaV Live displays are completely scalable and stretch to fit many screen sizes with no loss in resolution.

Intuitive and built for the entire graphics lifecycle

Graphics configuration is simple and intuitive, from design to operation to maintenance. Many display features often required complex, time-consuming scripting, such as display hierarchies and workstation layouts, are now available out of the box as drag and drop components. Also, with class-based objects, engineers only need to make a single change that can be automatically applied to items on a single display or across displays, resulting in significant time savings.

High Performance Operations Experience, Out of the Box

Built for Purpose

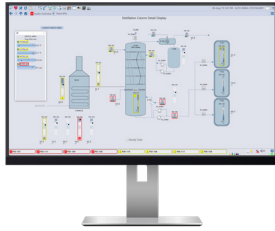

- The operations environment is highly customizable. Operators now have the ability to enhance their operations experience the fly, reducing the dependency on pre-engineered solutions.

Modern, State of the Art Technologies



- Zoomable, scalable vector graphics remove any dependency on screen resolution. Displays are accurately represented and automatically fit the available area, saving hours of configuration.

Easy to Design and Maintain High Performance Graphics

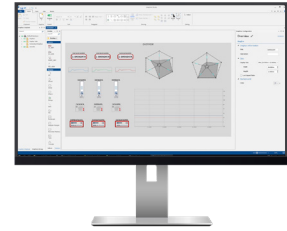

- A new Graphics Studio removes the reliance on scripting for common tasks. Get single-click access to graphics, built-in hierarchical navigation, directories, and more.

More than Just Process Data

Alarm List and Alarm Banner

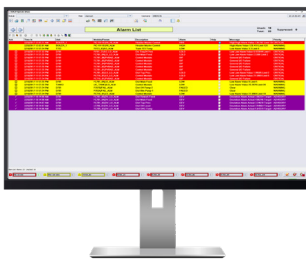

- Alarms are provided in order of importance to the operator, based on priority, acknowledgement status, active status, and area of responsibility.

Embedded Trending



- Historical charts are embedded directly into the operator displays, improving operator productivity by placing the information right where it is needed.

Integration of Live Video

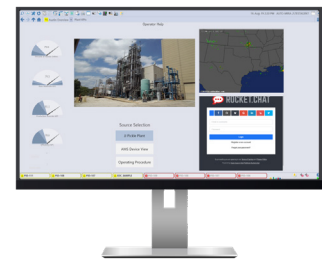

- Integrate live video directly into displays (e.g. CCTV), right out of the box. Operators can easily pan, tilt, and zoom the camera view directly from a display.

Improve Efficiencies with Intuitive Graphics Development, Reduced Scripting, and Simplicity

Reduced Scripting with Out-of-the-Box Features

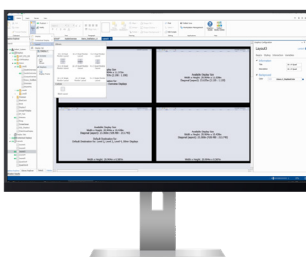

- Features like built-in display hierarchies and screen layouts are now easy drag and drop objects, with minimal dependence on scripting.

Class-Based Graphical Elements

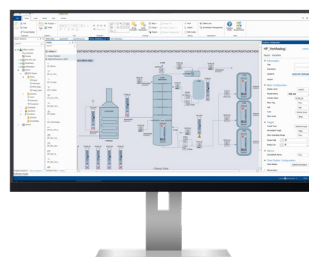

- Reduce project costs with class-based graphical elements (GEMs) in Graphics Studio to quickly update all GEMs across all displays by making one change to the class.

Centralized Workstation Management

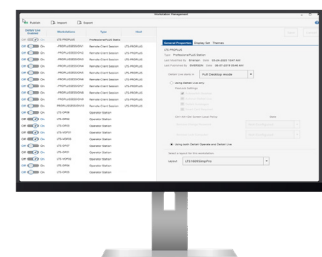

- Assign layouts, display sets, and themes to each operator workstation or remote client session from a single, centralized application.

Reduce process risk – use embedded alarm operations and analytic applications.



Ensure correct operator action every time

The DeltaV DCS provides in-depth, in-context operator guidance from the alarm list for a consistent operator response.

Gain visibility to inhibited and altered alarms

Native system functions provide the means to identify altered alarms and segregate suppressed alarms by ownership.

Avoid overwhelming effects of alarm floods

The DeltaV DCS provides robust in-controller dynamic alarm flood suppression capabilities. A configuration-free operator alarm view enables operators to visualize and recover from alarm floods faster and with less stress.

Easily deploy alarm management

DeltaV alarm operations are built into the system for a substantial reduction in initial and ongoing engineering effort.



DeltaV alarm management

Many demands are placed on alarm management solutions, but few facilities meet the needs adequately. Operators need to be able to perform well in both day-to-day and crisis situations. Alarm floods and improperly configured alarms are an impediment to situational awareness, and many facilities today are limited by the performance of their operations due to poor alarm management. An effective alarm management solution includes methods and tools that guide engineers to design an environment in which operators can act knowledgeably, accurately, and quickly.

The DeltaV system alarm operations and analytic applications are ready for use, unlike general-purpose layered alarm management systems that require extra hardware and software to engineer and maintain. The core DeltaV system provides a superior level of visibility to inhibited and altered alarms.

Consistent, Correct Operator Alarm Actions

Alarm Help

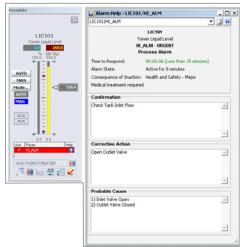

- Alarm instructions are immediately accessible from alarm lists.
- Senior operators can transfer alarm experience to junior operators through privileged entry of alarm help.

Alarm Descriptions

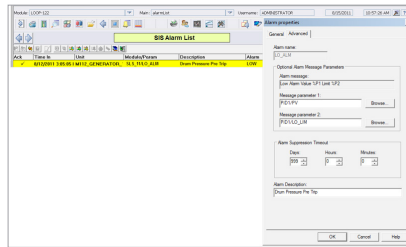

- Individual alarms may be given intuitive names for unambiguous operator identification.

Alarm Functional Classification



- Alarms of special significance can be isolated in alarm lists, shelved lists, event records, and elsewhere.

Built-in Alarm Flood Protections

Alarm Analytics

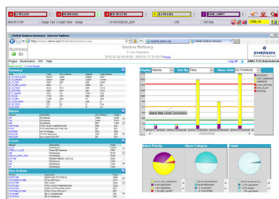

- Operators can navigate efficiently to relevant process graphics with no loss of visibility to the most critical alarms.
- Use the intuitive point-and-click dashboard to identify bad actor alarms and KPIs for alarm system performance monitoring.

Dynamic Flood Suppression

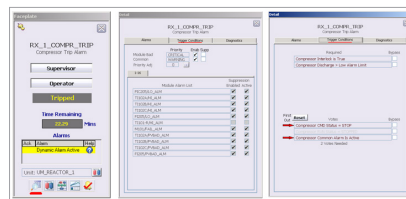

- Pre-engineered logic and graphics are used to detect and eliminate alarm floods.
- Runs in native system controllers for maximum speed and dependability.

Alarm Mosaic Alarm

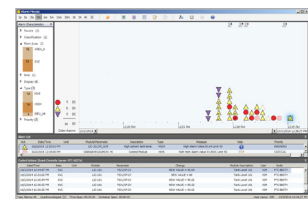

- Operators have a special alarm view to more easily manage alarm floods.
- A historic mode helps operators to visualize and learn from previous alarm floods.

Accountability for Altered and Disabled Alarms

Suppressed Alarm Visibility

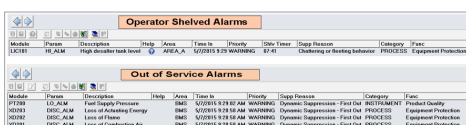

- Temporary operator shelving is distinct from maintenance- or logic-driven removal from service.

Suppression Reasons

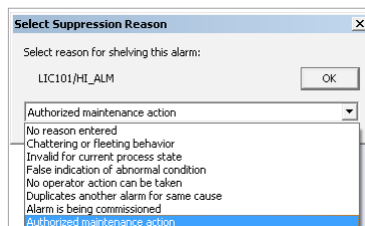

- Suppression reasons clarify intent and affix responsibility for restoration.

Alarm Audit

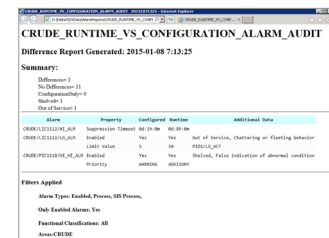

- A native system reporting function identifies disabled alarms and alarms with altered settings.
- Alarms of special significance can be audited with greater frequency.

Efficiently collect process data with fully integrated historians.

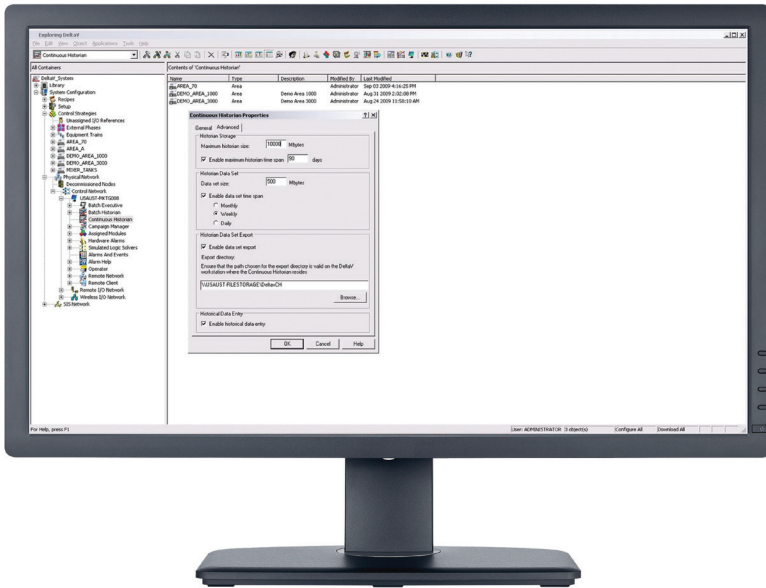

Accurately capture events

The DeltaV system collects event data at the lowest level in the system for a single precise record of every system event, alarm, and user action.

Gather information easily

Management of history data collection and presentation methods are integral to the DeltaV system's engineering and operations environments.

Meet demanding data-collection requirements

The DeltaV system provides tight integration with OSIsoft PI Server technology to meet highly demanding continuous history collection and enterprise data integration requirements.



DeltaV Historians

A dependable collection of essential process data is easy to establish and maintain over the lifetime of the system with the fully integrated set of DeltaV Continuous, Advanced Continuous, and Enterprise Historians. Configuration of history data collection is an integral aspect of the system control engineering environment.

The DeltaV Advanced Continuous and Enterprise Historians employ OSIsoft PI Server technology for top-performance for the most highly demanding history data collection and integration applications.

DeltaV history client applications provide a broad and dependable range of methods to access event, continuous, and batch history information — both on and off the system.

Three choices to suit a wide range of requirements

- DeltaV Continuous Historian, for the majority of in-system history data collection requirements.
- Advanced Continuous Historian, powered by OSIsoft technology for enhanced in-system data collection.
- Integration with an embedded or external OSIsoft PI Server for enterprise-wide history data collection, configured with DeltaV engineering tools for ease of use and efficient management of change.
- View relevant events with historical trends.

Enterprise Historian

Advanced Continuous Historian

DeltaV Continuous Historian

Event and Batch Historians

Accurate consistent event records

- Events are time stamped at the source for consistency and utmost precision.
- Configuration-free, batch-based data collection for batch-based analysis.

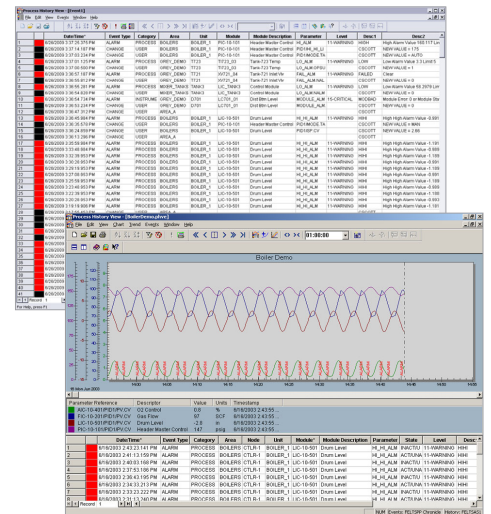

Visualization Clients

Information to make good decisions

- Native DeltaV applications power multiple operator and engineer history views to support effective decision making.

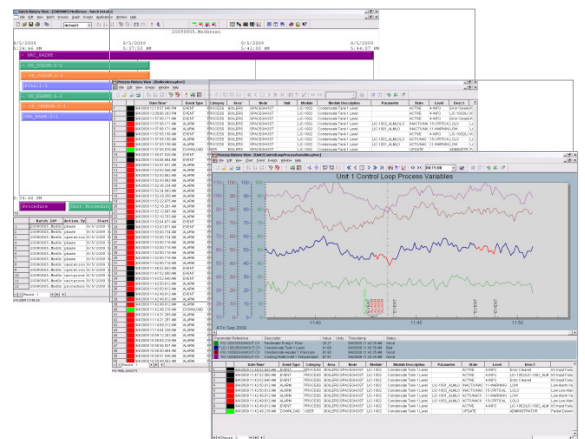

Access real-time operations data at your fingertips, virtually anywhere.

DeltaV™ Mobile delivers an entirely new operational experience and empowers teams to improve performance and safety by having key operations data on their mobile devices, anywhere.



Know Your Process Health On-Demand

Users can access information on the health of their operations on-demand, by viewing real-time process data, trends, and alarms from multiple DeltaV systems, historians, OPC sources, and more.

No DeltaV Configuration Required

DeltaV Mobile's native integration with DeltaV systems makes connecting to operations data easy by using existing configurations.

Securely Connect from Anywhere

DeltaV Mobile is built for cybersecurity. Easily access read-only data on-site with Wi-Fi or off-site with Off-Premise Access or VPN.



Your Operations at Your Fingertips

Your Operations Data, Mobile

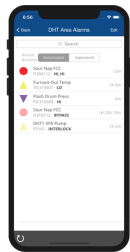

- Same richness of data and alarms from DeltaV operator stations on built-for-purpose mobile screens.

Streamline Workflows



- In-app collaborative features make it easier to share important information.

Receive Intuitive Notifications



- Get relevant process data, trends, and Alarm Help to take the right actions.

View Data with Context

Notifications



- Alarm notifications
- Custom notifications
- Escalation, claiming

Alarm Lists

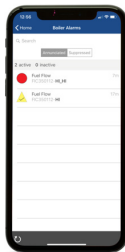

- Organized by preference
- Sorted by alarm priority
- See when alarms are inactive, acknowledged, OOS, shelved, etc.

Watch Lists



- Personalized lists of data
- Any parameter
- Real-time value, units, description, mode, etc.

Trends



- Integrated with DvCH or ACH
- Pinch and zoom
- Scroll back in time
- Tap to see value

One Mobile Platform with Many Use Cases

Process Engineer



How is my unit operating?

Plant Manager



What is the status of my critical KPIs?

Safety Engineer



What is the status of my SIFs?

Operator



What are my critical alarms?

System Admin



What is the health of my DeltaV hardware?

Meet project deadlines easily using intuitive engineering tools.

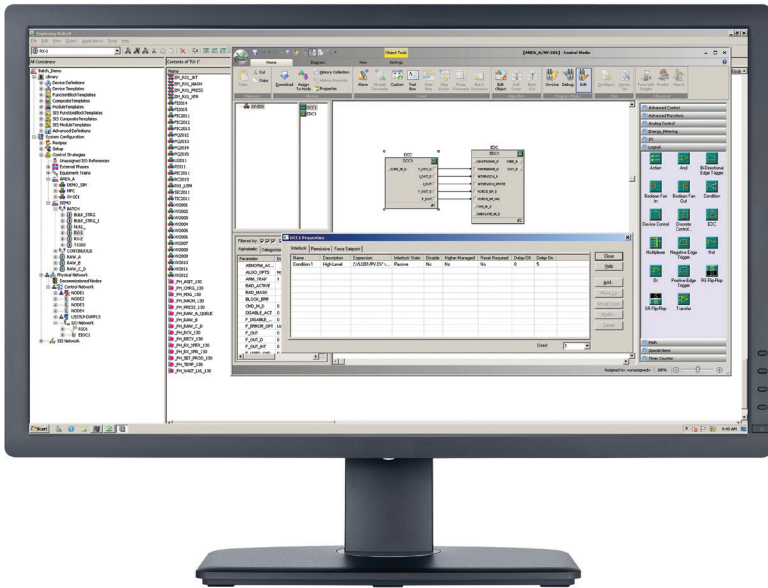

Simplify system configuration

Configuration Software Suite enables you to manage all aspects of your system configuration including hardware configuration, history, OPC, batch control strategies, and control strategies.

Diagnostics open a window to the health of your system

Every workstation, every controller, every device, every switch, and the network can be seen from the Diagnostics application.

Complete tasks where and when you need

Engineering Seat Licenses are available that turn an operator or maintenance workstation into an engineering workstation.



DeltaV engineering tools

With the pressure to get up and running on schedule, it's important to have a common set of engineering tools to configure, calibrate, and commission different types of equipment. This ensures that you can quickly complete your tasks in a single interface, without having to make the same changes in multiple locations. The DeltaV suite of engineering tools handles configuration, both locally and remotely, for all aspects of the DeltaV system and intelligent field devices.

A single, global database enables you to coordinate all configuration activities. Forget about data mapping between separate databases or referencing your process and engineering information by arcane registers or numbers. DeltaV engineering tools are developed with ease-of-use as a primary design criteria. The DeltaV system is designed to eliminate low-value engineering to ensure quick configuration, testing, and commissioning of any process manufacturing plant.

Intuitive Configuration Tools

DeltaV Explorer

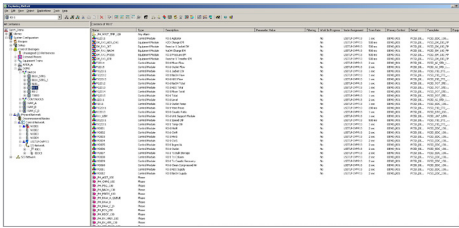

- Primary tool for system configuration.
- Presents the complete system in a single view and allows direct access to any item in your entire system.

DeltaV Control Studio

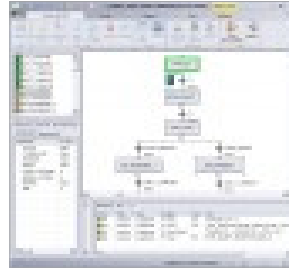

- The palette to build control strategies.
- Allows an online view of the process with debugging tools.

Fast Configuration Tools

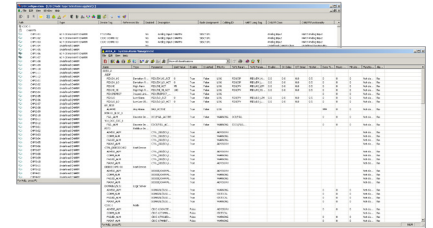

- Configuration tools that allow you to focus where the work is during a start-up.

Comprehensive View of System Health and Diagnostics

DeltaV Function Blocks

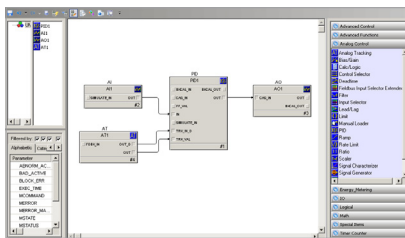

- Out-of-the-box function blocks make configuration of your control strategies intuitive and easy.

DeltaV Diagnostics

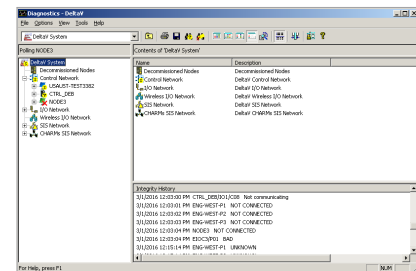

- Is the starting point to diagnose all the hardware nodes and subsystems of your DeltaV DCS.

An Efficient Environment Tailored to Your Needs

Configuration Audit Trail

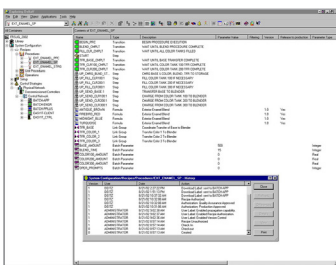

- Provides a complete version-to-version tracking of configuration.
- Records what changed, by who, when, and why.

User Manager

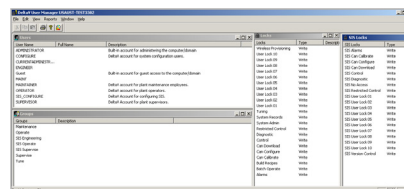

- Configure the users that need to have access to the DeltaV system from one application.

Engineering Applications

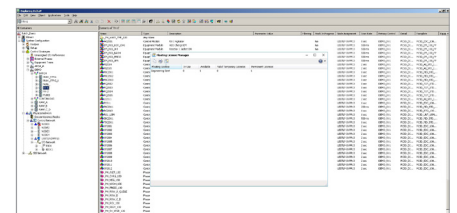

- Put engineering applications on the workstation when and where you need them.

Optimize control with an array of embedded advanced control applications.



Easily identify and tune underperforming loops

Properly tuned loops can decrease process variability and increase profits through improved product quality, throughput, and equipment availability. Using DeltaV InSight, you can continuously monitor control performance and identify the best areas to focus resources for maximum plant efficiency.

Improve product quality by reducing variability

Model predictive control (MPC) technology, used by DeltaV Predictpro, reduces variability by automatically accounting for process interactions to easily handle excessive dead time, long time constants, inverse responses, and loop interactions.

Increase profitability by operating closer to process constraints

Reduced process variability allows for optimal control performance without increased risk of violating operating constraints.



DeltaV Advanced Control

Manufacturers are being asked to do more with less: improve process performance with fewer engineers, increase reliability with lower maintenance budgets, and guarantee quality during changing conditions. Advanced control has proven to be an effective tool in optimizing operations, reliability, and quality but can be expensive to implement and maintain on traditional control systems.

DeltaV Advanced Control products provide a full array of applications including model predictive control, loop monitoring and adaptive tuning, quality prediction, and constrained optimization. Unlike other control systems, DeltaV Advanced Control is embedded in the system, using the same engineering environment, configuration database, and controller platform for unprecedented availability and ease-of-use.

Improved Control Loop Performance with DeltaV InSight

Performance Monitoring

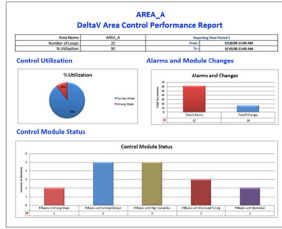

- Identify abnormal conditions which lead to poor control performance.
- Control monitoring and performance reports are available without configuration.

Loop Tuning

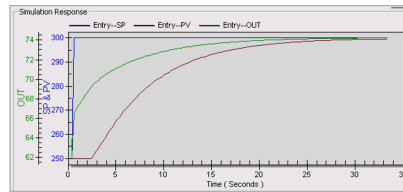

- Use on-demand tuning for selected loops.
- Adaptive tuning uses process learning to calculate tuning without plant tests.

Advanced Loop Analysis

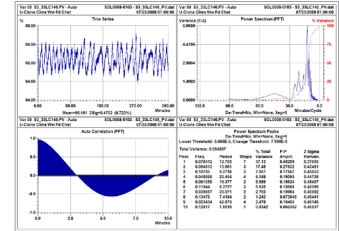

- The EnTech Toolkit provides advanced statistical analysis and loop tuning optimization for expert users to tackle the most difficult control problems.

Improved Quality, Increased Throughput, and Reduced Costs Using DeltaV PredictPro

Model Identification

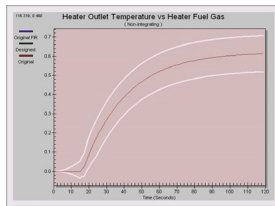

- Automated testing and integration with control database and historian simplify process model identification.

Model Predictive Control

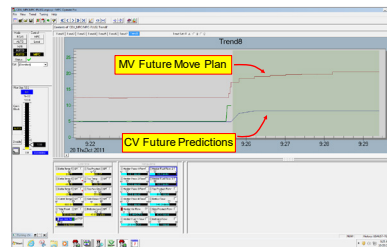

- Multivariable MPC handles difficult process interactions and delay times.
- Embedded MPC runs in controller or workstation using standard function blocks.

Control Optimization

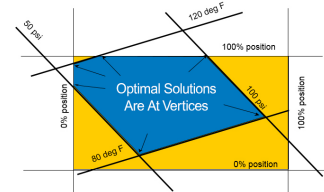

- The embedded LP optimizer pushes the process to an economically optimal solution within process constraints.

Superior Performance with Inferential Property Estimation and Non-Linear Control

DeltaV Neural

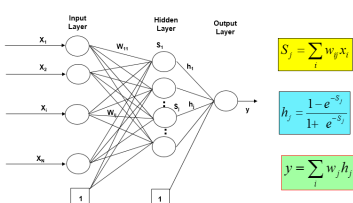

- Use online virtual sensors for process measurements, normally only available from lab analysis.

DeltaV Fuzzy

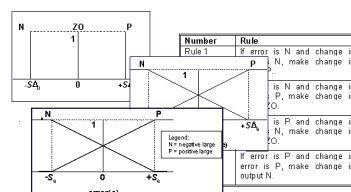

- Easy-to-use fuzzy logic non-linear controller has automated tuning using DeltaV InSight.

DeltaV Adapt

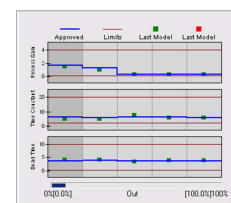

- Provides closed loop adaptive control for any DeltaV PID function block.
- Identifies optimal tuning from embedded process learning with no configuration changes.

Enhance quality by using consistent, integrated batch processes.



Optimize agility in batch manufacturing

DeltaV Batch enables flexibility so that manufacturing can respond quickly when customer demands change.

Simplify with a totally integrated batch solution

Built on ISA S88, DeltaV Batch is integrated into the DeltaV system and includes process cells, unit modules, phases, equipment modules, and control modules for easy batch operation.

Operate with confidence

Know when, where, and why changes are made to avoid costly errors and meet regulatory compliance including FDA 21 CFR Part 11.

See the whole picture with system integration

Through the web service interfaces available in the DeltaV system, batch production can be integrated with Manufacturing Execution System/ Enterprise Resource Planning operations to facilitate integrated manufacturing.



DeltaV Batch control and operations

Today's economic conditions, along with safety and quality concerns, demand confidence that your batch system helps prevent poor product quality, missed deadlines, and inaccurate or out-of-date reporting. Batch manufacturing often involves coordinating sophisticated sequencing across a plant while ensuring the use of proper equipment for the task.

Emerson's DeltaV Batch is modular and scalable to meet your needs — whether a relatively simple pilot plant or a very complex production facility. Abilities such as quickly identifying abnormal conditions, real-time analysis and adjustments, and automated reporting improve right-the-first-time performance for high-quality operation.

Minimal System Downtime High Product Quality

Batch Executive

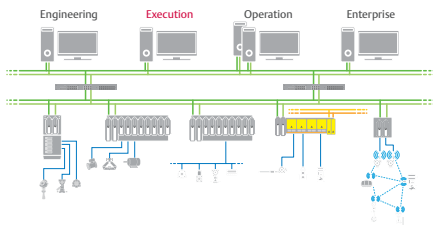

- Coordinates recipe execution and allocation of equipment.
- Capable of full redundancy to assure system availability.

Batch Analytics

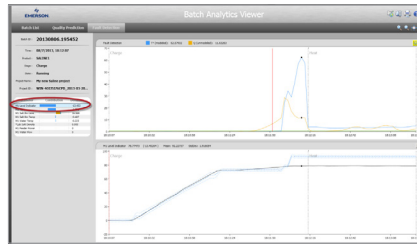

- Enables real-time product quality prediction and early fault detection.
- Reduces batch variability.

Batch Operations

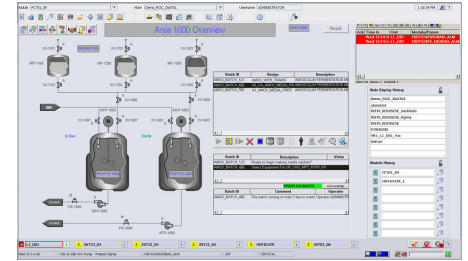

- Zero-configuration access to relevant batch information.
- Reduces errors through dynamic operator prompting.

Manufacturing Flexibility to Meet to Changing Demands

Automatic Unit Management

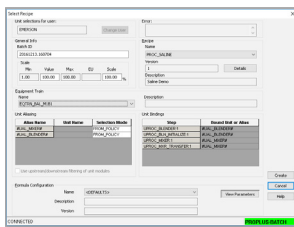

- Ensures repeatability through class-based unit, equipment modules, control modules, and unit phases.
- Allows on-the-fly changes through aliasing and dynamic unit selection capabilities.

Campaign Manager

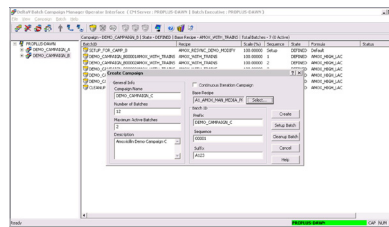

- Provides human centered design resource and recipe management.
- Provides an automatic scheduling and starting of repeated batches.

Recipe Exchange & Recipe Studio

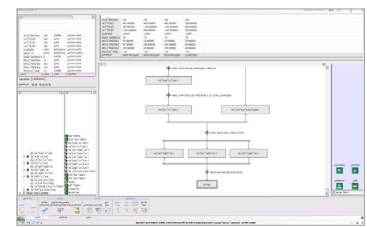

- Offers an open, programmatic interface to the DeltaV recipe management system.
- Imports and exports DeltaV recipes.
- Recipe Studio delivers easy engineering and one database.

Managing Change and Keeping Accurate Records

Configuration Audit Trail

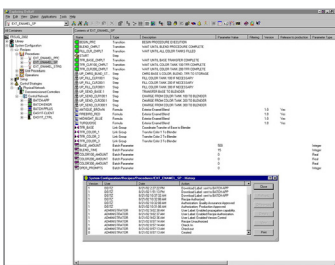

- Provides a complete version-to-version tracking of configuration.
- Records what changed, by who, when, and why.

Electronic Signatures

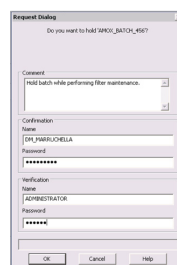

- Controls who can perform the batch tasks in the system.
- Requires a confirm mechanism with name and password to execute the action.

Batch Historian

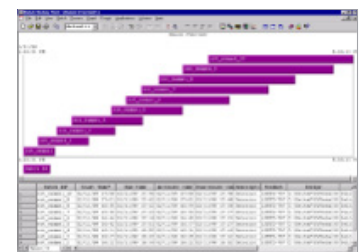

- Automatically collects batch data non-intrusively.
- Provides easy client access through open connectivity standards.

Achieve operational excellence through development, testing, and training simulation.



Minimize system errors with testing

Use DeltaV Simulate to check out control logic and operator interface prior to commissioning.

Improve worker effectiveness

Use DeltaV Simulate to provide the same configuration as your online DeltaV system for a realistic training environment.

Reduce project schedule

Minimize delays and incidents by providing a separate control simulation platform for implementation, testing, and training prior to start-up.



DeltaV simulation

Manufacturers are challenged to improve their operational excellence using advanced simulation capabilities. DeltaV Simulate improves quality of DeltaV systems and solutions by providing tools to thoroughly checkout configuration, operator displays, and advanced applications before commissioning online.

Users can reduce costs associated with engineering design, system configuration, and maintenance, while improving worker efficiency and minimizing the equipment required to simulate and train. Using realistic training environments with the same plant configuration and operator displays, increase your operator's productivity and improve safety.

DeltaV Simulate Standalone

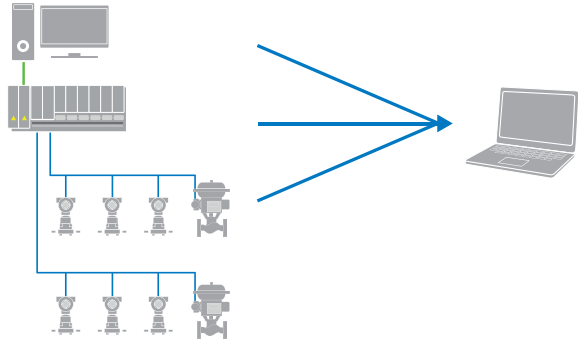

- Run DeltaV applications in a single PC environment for configuring controls, building displays, and simulating applications prior to commissioning.

DeltaV Simulate Multi-node

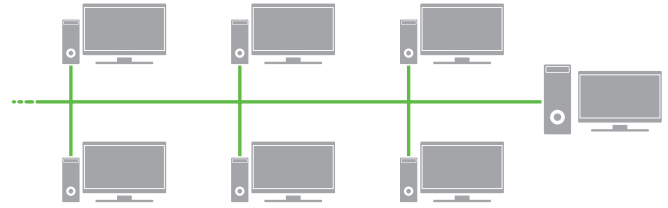

- Comprehensive control system simulation which supports multiple workstation types, controllers, SIS, and IO subsystems.
- Support for both real and virtual machine controllers and simulated I/O.

DeltaV Simulation for Operator Training

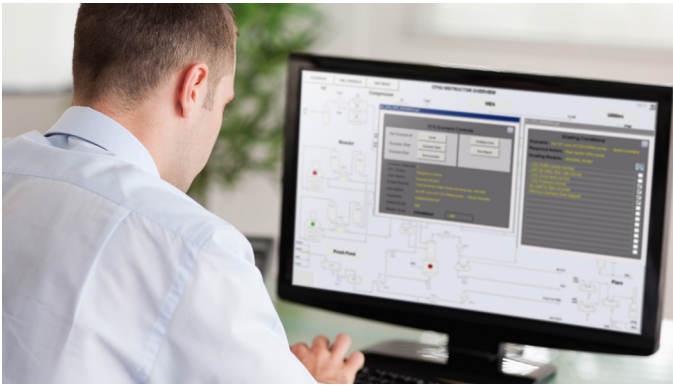

- DeltaV SimulatePro supports coordination with process simulators for powerful operator training solutions.
- Run predefined operator training scenarios with ability to freeze, replay, save and restore.

DeltaV SIS Simulation

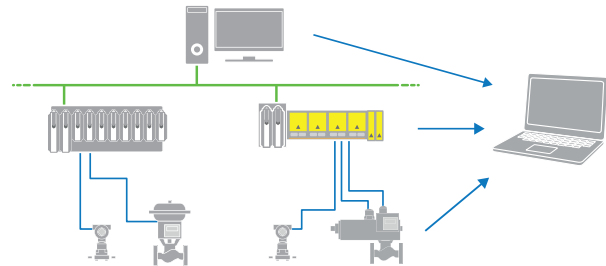

- Design and test safety instrumented systems without logic solver hardware.
- Run logic solver modules and operator graphics in test environment prior to field commissioning.

Virtual Simulation Environment

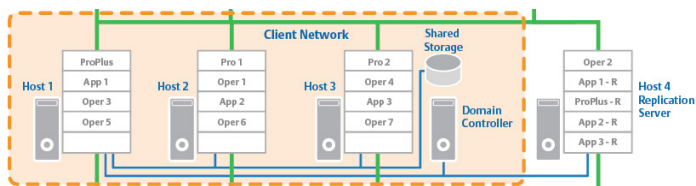

- DeltaV Simulate is supported in DeltaV Virtual Studio or VMWare environments.
- Easily create virtual machines for DeltaV workstations and control hardware using prebuilt VM templates.

Control Hardware Simulation

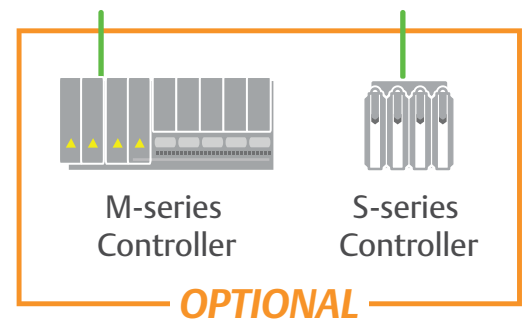

- Control simulation with virtual machine hardware controllers, CHARMs IO cards, SIS logic solvers, and Ethernet IO cards provide an effective way to checkout control configurations without physical hardware.

Tailor your system requirements with flexible controller and I/O hardware.

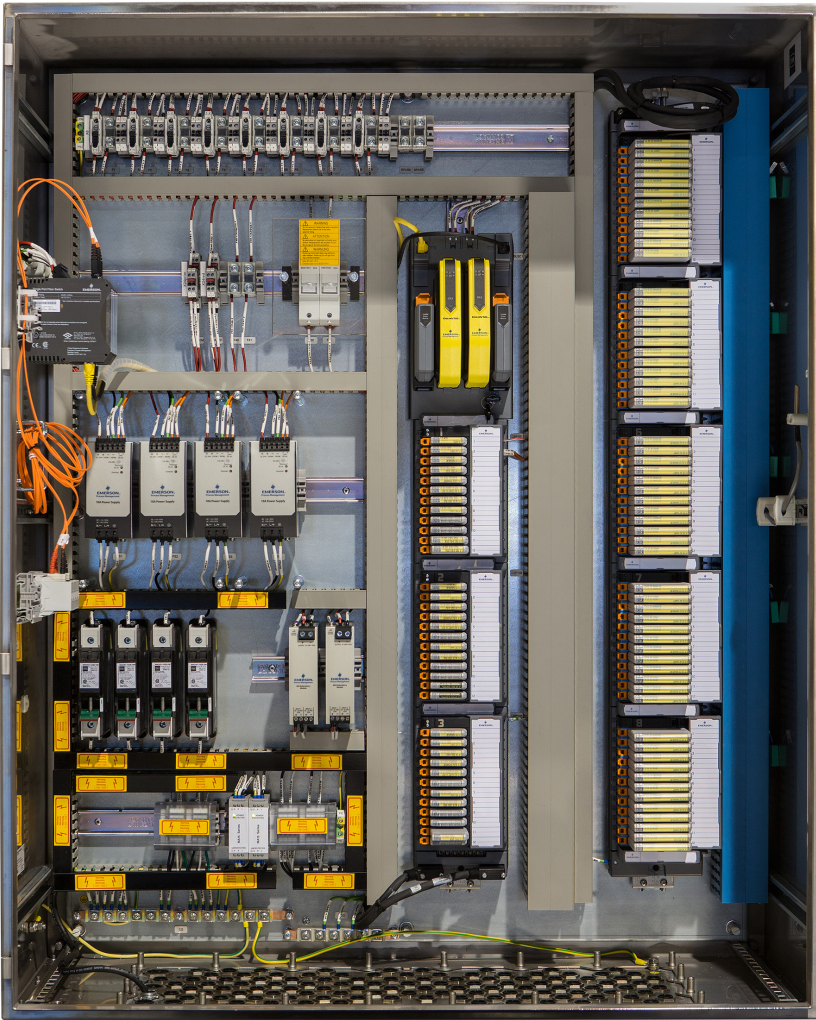

Simplify cabling

DeltaV Electronic Marshalling technology lets you land field cabling wherever you want, regardless of signal type or control strategy. Now you can terminate I/O even closer to field devices using Distributed CHARMS.

Place hardware wherever it is needed

DeltaV hardware is built rugged and flexible to mount almost anywhere. The hardware is designed for extreme field installation conditions and is rated for extreme operating temperature ranges.

Upgrade without downtime

Add components while the system is powered and running to expand and upgrade your system on-the-fly with no downtime.

Remain flexible with late changes

Make changes without adding extra costs of impacting your start-up schedule. Use Electronic Marshalling — no redesign or rewiring are required.



DeltaV controllers

The DeltaV system extends flexibility to fit your requirements by offering multiple types of I/O.

- Electronic Marshalling enables you to add various kinds of I/O when and where you want them.
- Traditional I/O offers standard analog and discrete I/O cards, including high density.
- Various bus cards offer connectivity to fieldbus devices communicating using a number of different bus technologies.

The DeltaV system's unique flexible field architecture delivers I/O on demand — providing you the I/O you want, when you want it, where you want it. It is flexible because you can now decouple the process design from the I/O infrastructure design to easily incorporate late process changes into the automation system.

Cabling Made Easier through Electronic Marshalling with CHARMs

CHARM Technology



- CHARacterization Module (CHARM) technology brings flexibility that allows field wiring of any signal type to be terminated anywhere.
- Intrinsically Safe for added safety in hazardous areas.

Remove Complexity of Field Wiring

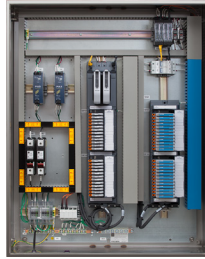

- Add I/O anywhere in the plant without affecting control room cabinets. No redesign, no rewiring.

Distributed CHARMs

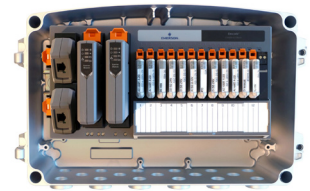

- Provide significant savings in system design, installation cost, and ease of maintenance with Electronic Marshalling, with the added safety for field wiring to hazardous areas.
- Small enclosures with up to 12 CHARMs can be installed closer to field devices, further reducing wiring and overall installation costs.

Value in DeltaV M-series DCS Control Hardware

Traditional I/O



- M-series hardware for traditional I/O offers flexibility during installation and provides the best value for your automation project needs.

Wide Range of Inputs



- The DeltaV M-series hardware supports a wide range of analog, discrete, thermocouple, and RTD inputs for your existing field devices.

Fieldbus Technologies



- A variety of DeltaV M-series hardware offers bus cards that allow connection to most field devices.

Flexible DeltaV S-series DCS Control Hardware

“Hot Swappable” Capabilities



- Add controllers, I/O cards, field devices, and workstations while the system is powered and running. Expand and upgrade your system with no downtime.

Optimized Hardware



- Marshalling and cross-wiring of power and grounding for FOUNDATION Fieldbus segments are already taken care of — even if redundancy is desired.

Human Centered Design



- The exterior hardware design delivers easy snap-in installation that prevents bent pins and over-tightening onto rails, and releases with the push of a button.

Powerful standalone. Easily integrated.

The PK Controller brings ground-breaking innovation and technology that can act as a powerful standalone for small-scale skid units and easily integrate into a plant-wide DeltaV DCS. With faster logic execution, built-in native Ethernet ports and native device protocols, the DeltaV PK Controller addresses a wide variety of applications and system sizes. The fit-for-purpose controller enables you to have a single native database and system allowing you to shorten project schedule and accommodate late changes.



Get advanced security

Prevent unauthorized access with multiple layers of protection and encryption technologies.

Add capabilities, not footprint

Get easy, cost-effective redundancy and six built-in Ethernet ports without adding footprint.

Easily integrate & reduce cost

No matter the stage, adapt to late projects changes without causing project delays or cost overrun.

What is Powerful Standalone?

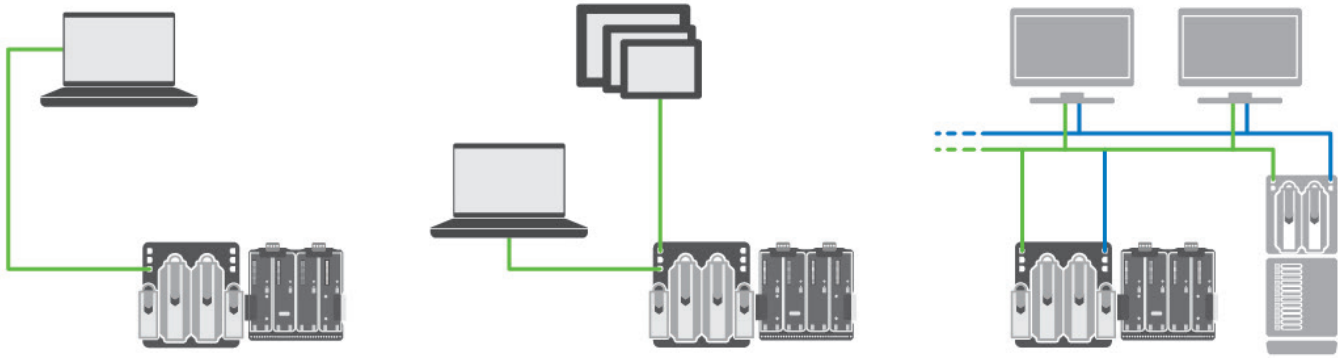

- Operate and configure your standalone applications with PK Controller Engineering software and PK Controller Engineering Station. Standalone PK Controllers do not require a permanent connection to a ProPlus to operate, PK Controller Engineering Stations provide a temporary local connection. For increased availability, get easy redundancy by simply installing the redundant controller onto the carrier next to the primary – with no added cabinet space or configuration change.

What is Easily Integrated?

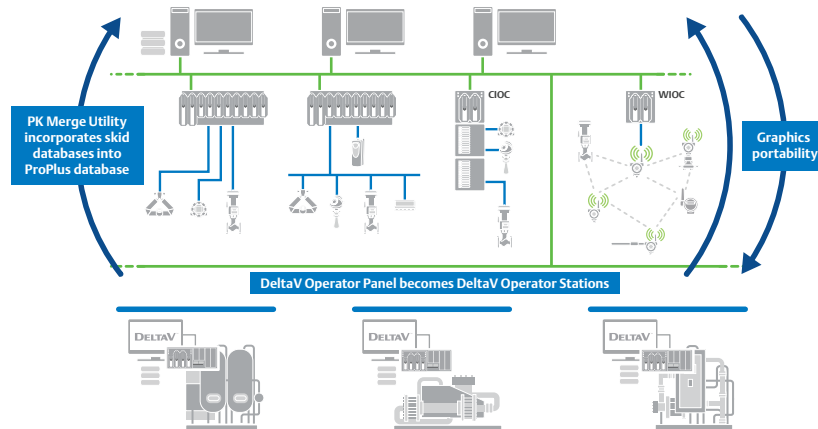

- Most skids come from OEMs with PLCs that can be challenging and costly to integrate and map into your DeltaV DCS. The PK Controller seamlessly merges into a larger DeltaV system, resulting in a single native database and system allowing you to shorten project schedules, accommodate late changes, and streamline your automation strategy.

Get the Ultimate Flexibility in I/O

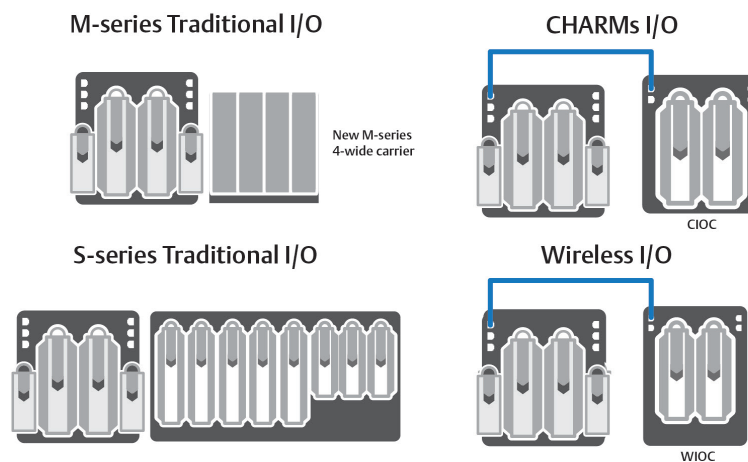

- The PK Controller supports most DeltaV I/O families including M-series traditional, S-series traditional, CHARM I/O Cards, and Wireless I/O cards, enabling you to select the I/O family that best meets the specific needs of your application.

Gain confidence knowing your system is secure with our fully certified DCS.



Easily apply security using DeltaV built-in security features

The DeltaV control network architecture creates a separate control system network completely segmented from other networks in the plant, delivering a system inherently protected from unauthorized external access.

Reduce implementation effort with no-hassle security solutions

DeltaV Smart Switches provide auto port lockdown to prevent unauthorized access to the network from switch ports.

Monitor and manage network devices within the DeltaV system

All routine system maintenance and troubleshooting is done from secured DeltaV workstations so physical access to equipment is not required.

Certified ISA Secure SSA Level 1 and IEC 62443 compliant

The DeltaV DCS Level 1 certification is comprised of security development lifecycle assurance to make sure our design and code practices meet the IEC62443 standards, and the functional security assessment to verify that the DeltaV security features and functions meet the minimum requirements for Level 1 certification.



DeltaV security and networks

Emerson's expertise helps ensure your system is designed, implemented, and maintained more securely. DeltaV hardened workstations are defined based on industry benchmarks and operating system recommendations so that only specific services and settings are enabled. Built-in features and functions simplify the work of managing and auditing security settings. A complete set of services can be provided to design and implement the cybersecurity monitoring solution that best suits your organization's security policies.

Emerson solutions and services deliver a defense-in-depth strategy to secure your critical infrastructure. DeltaV features - such as system hardening, network lockdown, and intrusion prevention - help to drive system availability. Recommended practices can be put into place to dramatically reduce cyber-threat risks. In case of a cybersecurity issue, there are processes ready to help reduce downtime, such as the Backup and Recovery process which help customers recover workstations and servers quicker than reinstalling everything from scratch.

Defense-in-Depth Strategy

Recommended Best Practices



- The DeltaV Security Manual summarizes recommendations such as network segmentation, secure remote access, and workstation hardening, to reduce the attack surface of DeltaV control systems.

Built-in Applications and Features

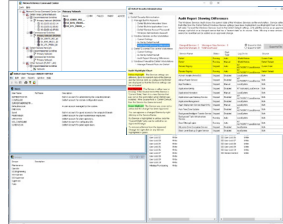

- System file and services auditing, switches port lockdown, and user management help customers protecting their DeltaV control systems.

SIEM and Network Security Monitor for DeltaV Systems

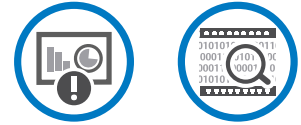

- DeltaV system events, logs, and network traffic can be collected and presented in a custom-built graphical interface for security audits.

Easy, secure set up

Emerson Smart Firewall



- Built-for- purpose perimeter firewall and intrusion detection system designed to provide an easy to install and maintain security solution for the DeltaV DCS.

DeltaV Smart Switches



- Plug-and-Play network components based on commercial off-the-shelf switches that are pre-configured to be used in the DeltaV Area Control Network.

DeltaV Firewall-IPD



- Easy to deploy transparent firewall to be used in a DeltaV network which protects DeltaV embedded nodes from unauthorized access and cyber-attacks.

Cybersecurity Management Services

Custom and Basic Cybersecurity Assessments



- Cybersecurity Assessment Services provide expert consultation and assistance with evaluation, testing, and implementation support.

Application Whitelisting and Endpoint Security for DeltaV Systems



- Centrally-managed application control and anti-virus solutions specially designed for DeltaV control systems to help customers protecting workstations and servers.

Automated Patch Management



- Patch Management establishes a proactive strategy for anti-virus signature screens, security patching, and hotfixes based on automated procedures.

Make installation and maintenance trouble-free using built-for-purpose workstations.



Reduce hardware costs

Get accurate requirements without over-specifying the hardware and adding unnecessary costs.

Lower the cost and time of implementation

Software settings are automatically configured and do not require any manual operating system setup to support the proper installation of DeltaV software.

Improve the operator experience

Pre-installed and tested drivers, video cards, and management software provide improved performance.



DeltaV Workstations

In a non-DeltaV environment, success in maintaining computers is often elusive — and expensive in time, effort, and money — due to incompatibilities between computer hardware and software. DeltaV has solved these issues by providing a variety of built-for-purpose computers specifically manufactured and tested to support DeltaV applications.

Using DeltaV workstations eliminate potential software incompatibility headaches involved in implementing and maintaining control workstations. DeltaV Workstations are only available from Emerson and are required to be used for all DeltaV Workstation deployments.

Workstation Hardware



- DeltaV workstations run on a specific set of preselected Dell computer hardware specifically chosen to provide the best cost performance solution for your DeltaV system. We provide you with a guaranteed solution to deliver the performance required.

iOps Workspaces



- IOps workspaces are offered in three flavors: Basic, Advanced, and Theater. The iOps Workspaces add operator performance with its ergonomic and highly adaptive structure, providing the flexibility to connect to any video source or console.

Four-Monitor Workstation



- Real-time video feeds greatly help to improve security and safety. Video tracking of certain process emissions enables better environmental compliance.

Dual Monitor Workstation

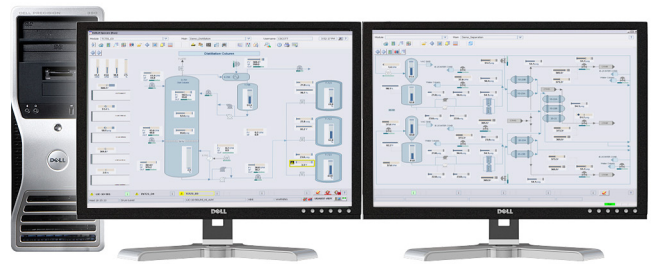

- The DeltaV Dual Monitor Workstation offers a larger viewing area, driven from a single keyboard and mouse. Spatial placement of the applications allows the user to quickly locate and use the appropriate application.

Streamline virtualization in an integrated environment designed for process control.



Easily create and use a virtualization environment

Virtualization is integrated within the DeltaV system so that the average control system administrator can set up, operate, and maintain their DeltaV system without extensive virtualization knowledge or experience.

Increase flexibility and productivity

Easily setup and maintain multiple systems for control development, testing, and training. In fact, virtual machines that include field system configurations can be created and tested without disrupting process operations. You can also create virtual networks and add host computers.

Save time and money consolidating hardware

Consolidate workstations on host servers to reduce computer hardware, installation, and maintenance costs. Fewer workstations also mean a smaller footprint, very important to facilities with limited control room space.

Be confident in high availability and disaster recovery

Virtual machines are easily reassigned to backup host computers, and may be automatically restarted when implemented in a high availability virtual environment.



DeltaV virtualization

Distributed control systems often require many computers, which can be expensive to maintain and disruptive to upgrade. Emerson's DeltaV Virtual Studio gives you the flexibility to easily create and upgrade your control system workstations. You don't have to be a virtualization expert to deploy a virtualized automation platform.

With DeltaV Virtual Studio you can keep your system up and running with little or no disruption or downtime for system upgrades, maintenance, and security. DeltaV Virtual Studio is designed specifically for virtualization of process control systems, with a workflow and feature set that is easy to understand.

DeltaV Virtual Studio

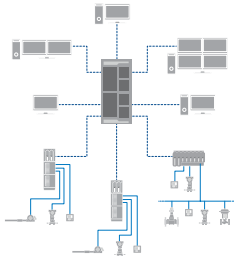

- DeltaV's integrated environment for virtualization applications supports easy implementation and management of virtual DeltaV control systems for both offline and online production systems.

Virtual Machine Templates

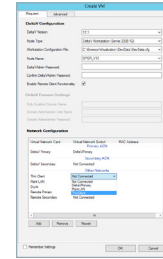

- DeltaV Virtual Studio VM templates allow you to create DeltaV nodes from a single configuration dialog, without separate software installation.
- Create custom templates from existing virtual machines.
- Templates available for DeltaV v11.3.1 and later.

Increased Reliability and Productivity

Easy Network Connections

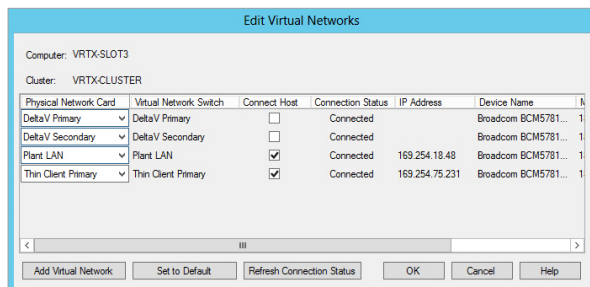

- Preconfigured virtual networks eliminate configuration errors and increase productivity.
- Easily connect to DeltaV networks from drop-down menu lists.

High Availability and Disaster Recovery

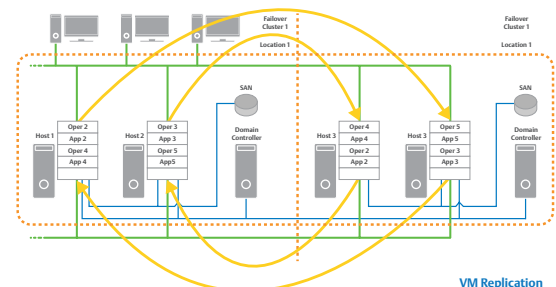

- Automatic failover and live migration of virtual machines to maximize availability during host failure or maintenance.
- VM Replication and DeltaV Backup and Recovery to protect from corruption and disaster events.

Hardware Options to Meet Your Needs

Integrated Hardware Platform

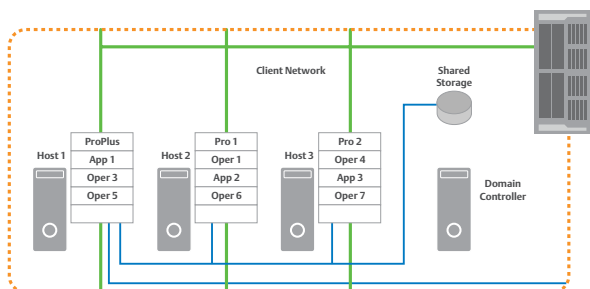

- Designed for virtualization, the Dell PowerEdge VRTX blade server and network storage comes preconfigured for use with DeltaV Virtual Studio.

Virtual Control Hardware

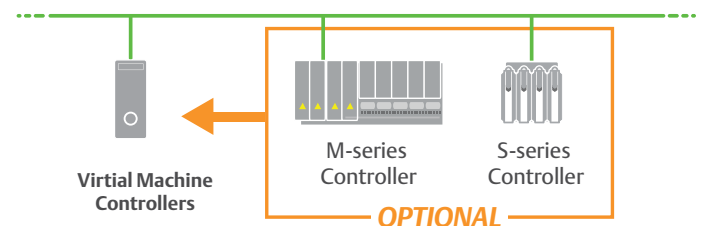

- Use virtual control hardware to develop and test control configurations without physical hardware.
- Virtual control hardware available for controllers, CHARMS and Ethernet IO, and SIS logic solvers.

Save time and effort with standards-based data connections.

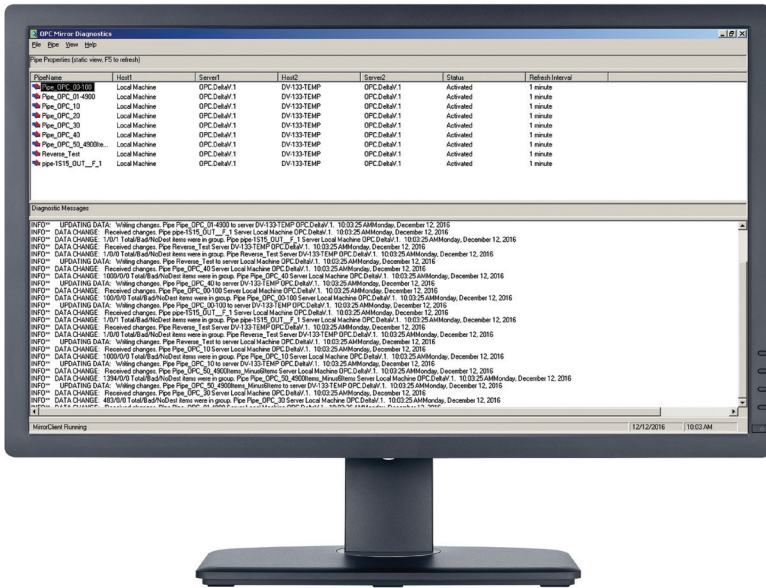

Share real-time process updates

Using OPC Classic, OPC UA and robust Web Services, the DeltaV system connects to any layer of the manufacturing environment.

Eliminate manual data-mapping errors

The DeltaV system's plug-and-play design with field devices allows operating and diagnostic data to start flowing with minimal configuration.



DeltaV data integration

When data flows among systems — from the field to the control system to the management systems and back — you understand the power of how information influences success. The DeltaV system was engineered to promote ease of connectivity. Once the data is in, the system treats it as native and streamlines the complete business process. All this is implemented within easy-to-use configurations.

At the device level, the DeltaV system provides plug-and-play capability for runtime and diagnostics in a variety of standard protocols: *WirelessHART*, HART, Fieldbus, DeviceNet, and Profibus DP. Decision makers at every level in the plant including engineering, operations, and production can get the critical data they need, reliably, securely, and in real time.

Secure and Reliable Exchange Data Between Different Systems

Protocol Capabilities



- Natively supports OPC UA for seamless integration to IIoT enabled devices
- DeltaV provides all three classic OPC classic servers: OPC Data Access , OPC Alarm and Events, and OPC History Server.
- Offers OPC. NET 3.0 based on WCF for easy integration.

Easy Connection to External Ethernet I/O Networks and Digital Bus Field Devices

Flexible Networking



- The Ethernet I/O Card provides a platform to access Modbus TCP, Ethernet/IP, IEC 61850 MMS, and OPC UA Devices.
- Robust embedded non-Windows platform for interfacing with Industrial Ethernet networks. Supports control functionality and various networking topologies.
- Running native OPC UA enables seamless integration for IIoT enabled devices.

Remove Complexity of Field Wiring



- The VIM2 card provides an interface to Ethernet I/O networks and devices that use the Modbus TCP/IP, PROFINET, or Ethernet/IP protocols.

Serial I/O



- Serial I/O card provides an interface to Ethernet I/O networks and devices that use Modbus.
- Other custom drivers are available.

Native Integration with Smart Field Devices

Traditional I/O



- HART information and diagnostics from smart field devices are fully accessible throughout DeltaV applications and AMS Device Manager.

Field Device Support



- FOUNDATION Fieldbus information and diagnostics from smart field devices is fully accessible throughout DeltaV applications and AMS Device Manager.

WirelessHART Integration



- *Wireless*HART information and diagnostics from smart field devices are fully accessible throughout DeltaV applications and AMS Device Manager.

Improve productivity and safety with wireless plant network solutions.

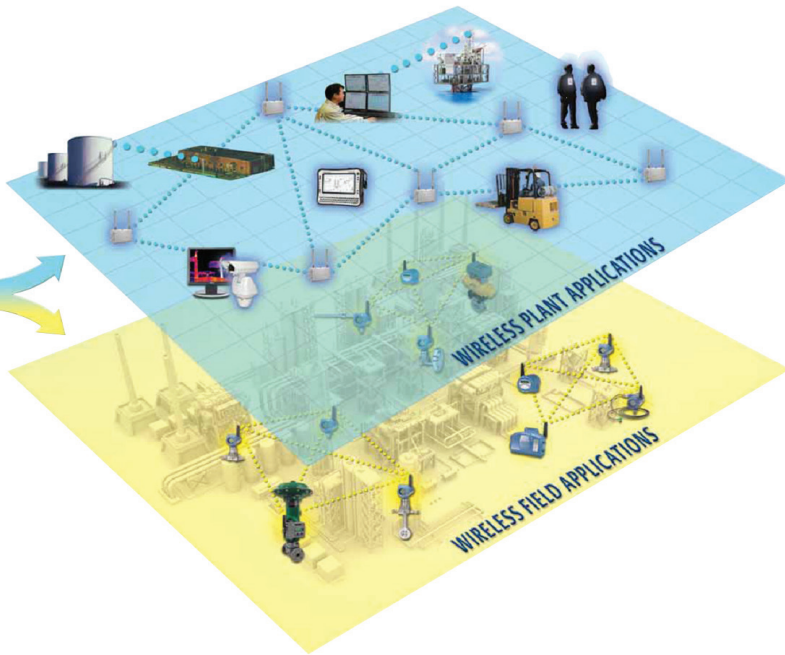

Save time with a scalable solution

Scalable solutions allow you to start anywhere and easily expand the scope of your wireless implementation.

Rely on wireless designed for industrial settings

The industrial mesh access points are designed for industrial Wi-Fi deployments and open standards. Field instrumentation communicates using the *WirelessHART* protocol.

Optimize with self-organizing, self-healing networks

The intelligent mesh protocol dynamically optimizes the best route to the wired network within the mesh, mitigates interference, and ensures high network capacity.

Repel threats by using robust, embedded security

Powerful and secure solutions enable confidential communications, policy controls, and threat defense capabilities to protect information and systems from wireless attacks.



Wireless plant network solutions

The wireless solutions developed for plant operations include hardware, software, and services targeting applications which would normally require extra time, additional investment, and more resources, if done based on wired infrastructure.

The solutions are engineered according to customer needs and can deliver video, voice, and control system information based on a wireless infrastructure. Field operations and the connectivity to remote sites or process signals are also part of the Wireless Plant Network solutions portfolio.

Wireless Field Data Backhaul



- Wireless solution that integrates field instruments data with the process control system at significantly lower cost and implementation time over wired solutions.

Wireless Mobile Workforce



- Mobility can dramatically improve worker productivity by using cutting-edge wireless technology to provide instant access to process control data, maintenance information, and operation procedures.

Wireless Remote Video Monitoring

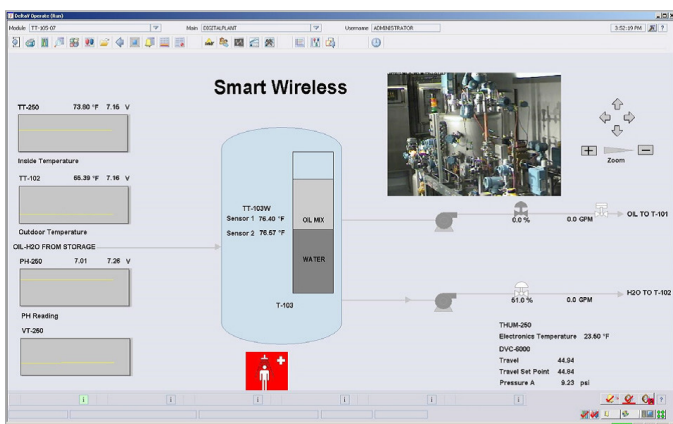

- Real-time video feeds greatly help to improve security and safety. Video tracking of certain process emissions enables better environmental compliance.

Wireless Control Network Bridge



- Wireless technology can easily connect control system units securely and cost-effectively where wired connections are too expensive to deploy or even impossible to be considered.

Gain a competitive advantage by employing reliable equipment.

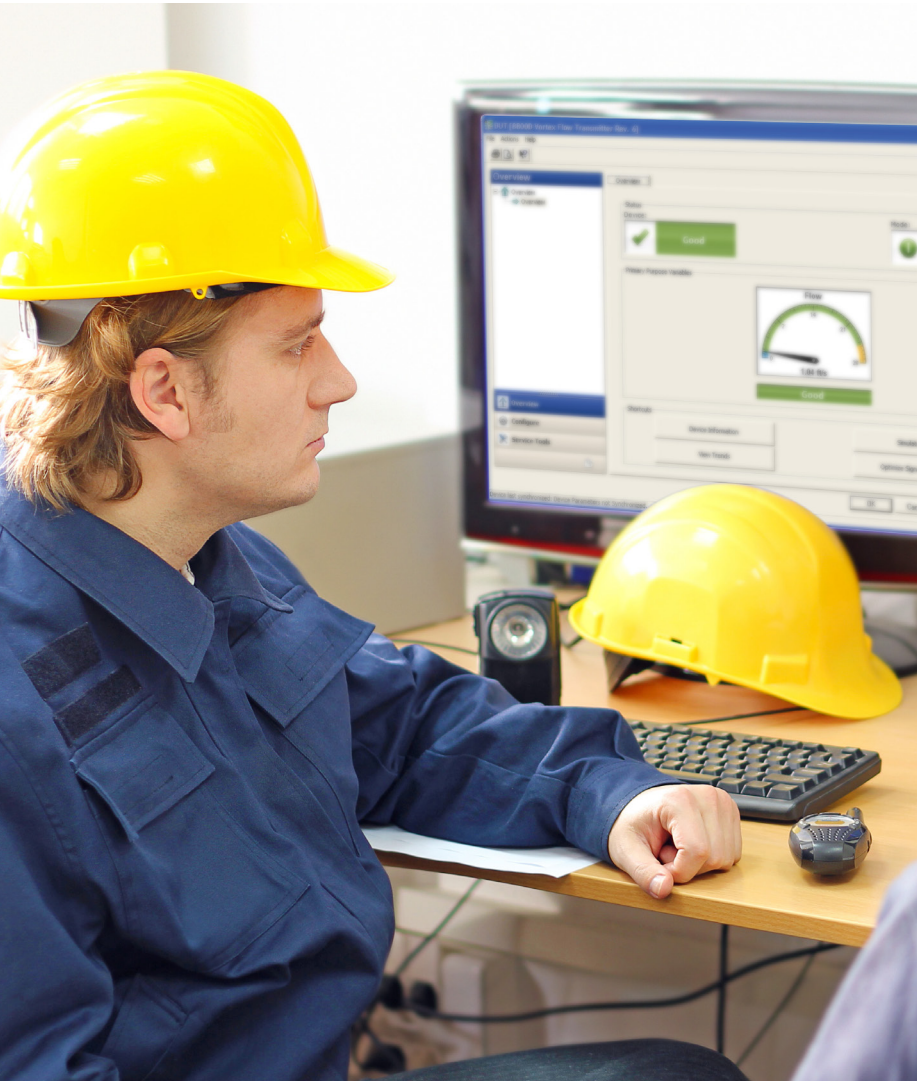

Reduce start-up time while reducing errors

Reduce commissioning time by up to 80% with device templates for mass device configuration. Partnering the DeltaV DCS with AMS Device Manager, each configuration is defined once and used many times. Instead of applying to devices individually, configurations are applied to all common devices simultaneously, ensuring accuracy and consistency while saving hundreds of work-hours.

Make informed production decisions

Equipment health alerts on your operator screen deliver actionable information to enable real-time adjustments to protect equipment, quality, and throughput.

Increase availability by using reliable information

The DeltaV system uses validated data and equipment health information from intelligent field assets to ensure the right control action is taken to prevent unplanned shutdowns.



In an increasingly competitive market, organizations are challenged to run their plants more profitably and with greater efficiency. Eroding condition of field equipment reduces throughput – or worse, halts production completely. By integrating field diagnostic information with the control system, operators can quickly assess the condition of instruments, valves, and mechanical equipment in order to make real-time adjustments to sustain throughput and quality.

The DeltaV system can receive critical machinery health alerts from the AMS 6500, providing actionable information for operators to protect the condition of mechanical assets. Integration with AMS Device Manager allows operators to significantly reduce commissioning time during start-ups. When in operation, field device alarms and diagnostics are easily accessible to aid decision-making.

Faster Start-Up and Commissioning

Smart Commissioning

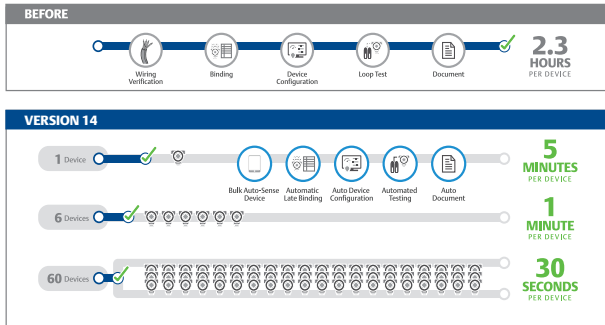

- Drastically reduce commissioning time by decoupling the physical I/O design and using templates to commission and validate devices in mass.

Decrease Interlock Verification Time

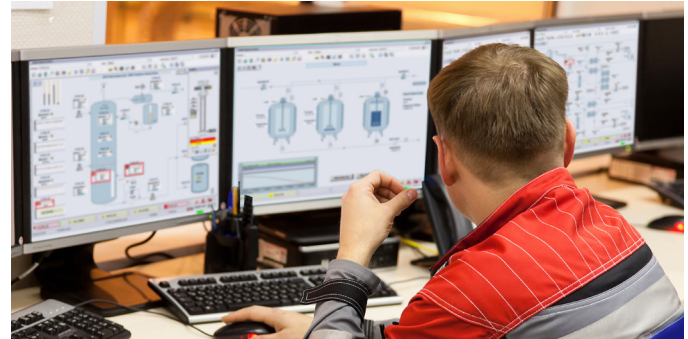

- Coupled with AMS Device Manager, verify all wiring from the field to the control room so you can focus on checking the DCS configuration and logic.

Improved Operator Visibility to Risk

Comprehensive View of Assets

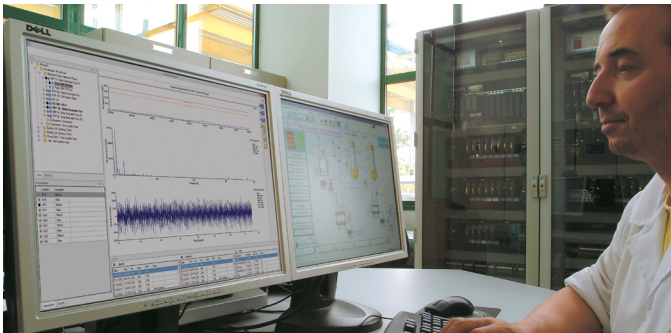

- Gain a system-wide view of relevant device alerts and automated documentation.

Improved Efficiency with a Single Platform



- Seamlessly launch device tasks and methods or view device diagnostics on a seamless user interface in an integrated operating environment.

Maintenance of Turbomachinery to Protect Production

Integrated Machinery information

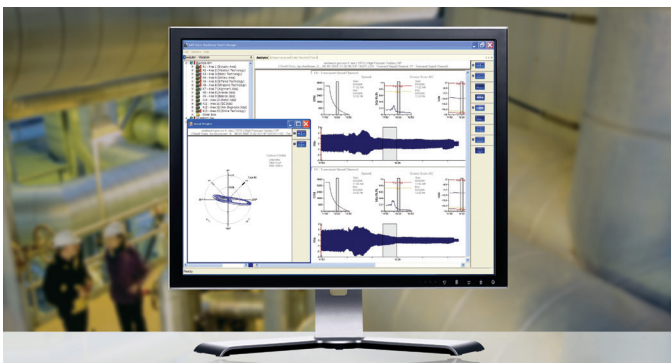

- Fast, trouble-free integration between the AMS 6500 and the DeltaV system delivers critical machinery health feedback to operators.

Machinery Issues Detected Earlier



- The AMS 9420 delivers critical vibration information directly to the control room to help operators identify potential production risks.

Take a modern approach to increase safety integrity while improving process availability.

The DeltaV SIS™ takes a modern approach to increase safety integrity while improving process availability. The proven DeltaV safety instrumented systems (SIS) continuously monitors your plant's safety devices' status and diagnoses the health of the entire safety loop—dramatically reducing your risk. The logic solver, certified to safety integrity level (SIL) 3 uses electronic marshalling technology to reduce your installation, commissioning and maintenance costs while substantially reducing your equipment footprint.



Improve Safety Integrity

The modern DeltaV SIS takes into account devices' predicted lifespan and pre-empts end of lifecycle with maintenance notifications and testing, so your SIS integrity stays stable longer.

Maintain Project Schedule While Adapting to Changes

DeltaV SIS with Electronic Marshalling lets you maintain safe operations without putting production at risk every time you make a system change. Simplify design, installation, wiring, and commissioning while eliminating traditional system rework and redesign.

Look at Space Differently

DeltaV SIS enables you to mix I/O, and bring homerun cables straight from the field into a standard cabinet. So small spaces are less limiting—even during hot cutovers when cabinet contents are being reorganized and the system seems to grow ten-fold.

Reduce Undetected Failures

Be confident that every safety loop will operate when needed. DeltaV SIS provides an integrated, constant monitoring approach for the complete safety loop—from sensor, to logic solver, to final control element.

Reduce Engineering Effort

The IEC 61508-certified SIS function blocks deliver functionality right out of the box, simplifying the implementation of complex SIS applications. No custom code is required to implement common SIS tasks. The result is faster configuration and troubleshooting of SIS logic.

Overcome Complicated Integration

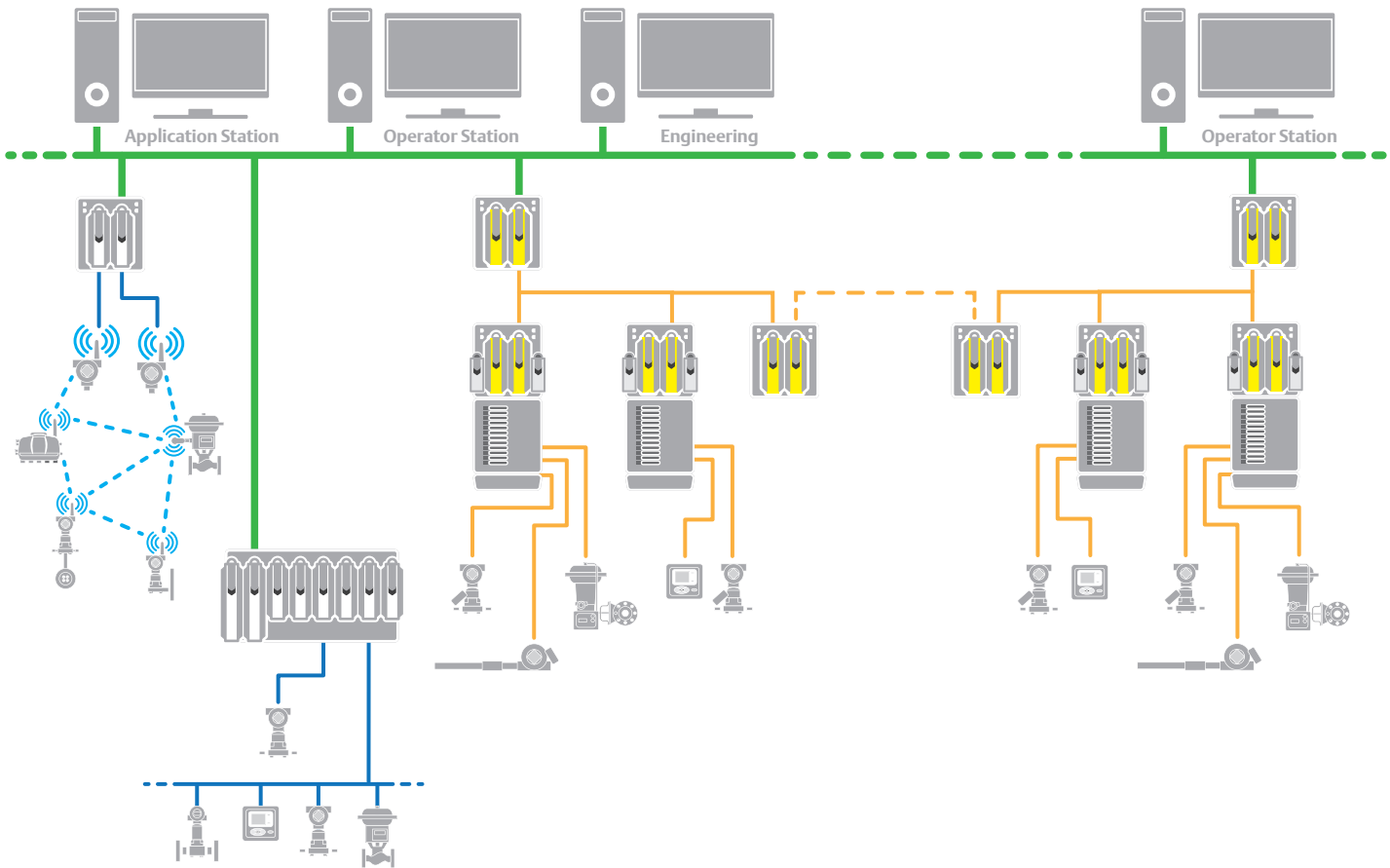

- Familiar, intuitive applications for greater availability -- DeltaV SIS Integrated Architecture

Reduced Configuration Effort

Traditional Approach

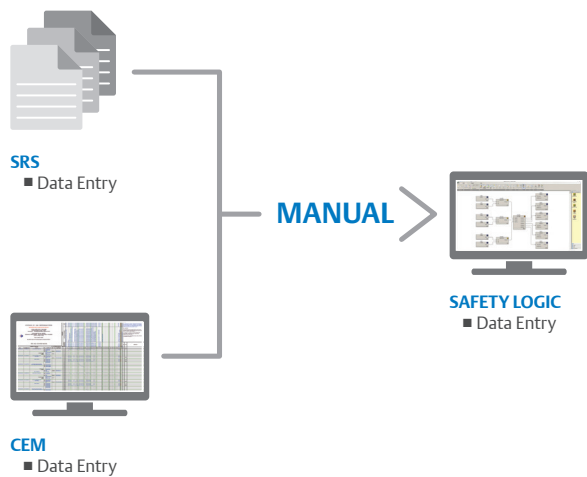

Modern Approach

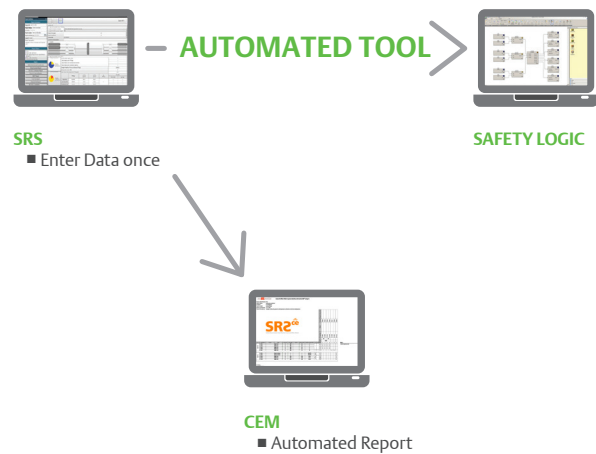

- Transfer design to safety logic configuration with minimal manual effort while eliminating errors
- Facilitate traceability between configuration and safety requirements
- Increase configuration consistency and reduce manual errors

Global services and execution capabilities guide you to success.



Plan and design

Collaborate with our experienced experts to ensure your project gets off the ground on the right foot.

Implement and build

From process management to automation implementation, Emerson's highly trained service personnel have the know-how to ensure a smooth build.

Operate and maintain

Maintaining your operations over many decades is a large job. You need a reliable partner in order to get the most out of your investment.

Improve and modernize

Guidance and advice about when and how it makes sense to improve your plant, letting you modernize intelligently and effectively without wasting time or money.



DeltaV DCS services

To complement our best-of-class technology, Emerson offers services that enable you to improve your financial results by unlocking the potential of your process operations and assets. Emerson provides the expertise and global resources to help you dependably define, execute, and support a strategy throughout the lifecycle of your operation.

Emerson's industry experts help companies like yours improve business performance and protect their automation investment with an array of services from opportunity assessment through project execution, commissioning, maintenance, performance improvement, and training.



Project Services

Emerson project services span a wide range of commercial and contracting strategies including Front End Engineering Design (FEED), MIV, PAS, ICSS, and Main Automation Contractor (MAC) projects. Services vary in scope and size from basic consulting to complete turnkey responsibility for projects of any size. The leadership from Emerson's Project Management Office (PMO) drives best practices, improvement, service excellence and consistency around the world.

Lifecycle Services

Partner with Emerson to design and effectively execute a comprehensive maintenance strategy for your system that allows you to operate efficiently and safely. Develop a long-term lifecycle strategy to improve your plant reliability with better insight into system and equipment health. Access the right expertise and training to strengthen plant performance and achieve your business goals.

Educational Services

Get up to speed quickly and upskill personnel on the easy to learn, use, and maintain DeltaV system. A host of courses are available for engineers, technicians, operators, and anyone else who needs to know the installation, configuration, maintenance, troubleshooting, and operation of the DeltaV distributed control system.



Expertise and innovation to deliver proven results

With constant pressure to cut costs, increase output, reduce energy use, and improve safety, turn to Emerson for technologies, services, and expertise to solve your toughest problems.

- Distributed control systems
- Safety systems
- Operations management
- Asset reliability
- SCADA
- Reservoir management

DELTA^V

Emerson

North America

1100 W. Louis Henna Blvd.
Round Rock, TX 78681-7430,
United States
☎ +1 800 833 8314

Latin America

1300 Concord Terrace Suite # 400
Sunrise, Florida 33323,
United States
☎ +1 954 846 5030
☎ +1 954 846 512

Europe

Blegistrasse 21
6341 Baar,
Switzerland
☎ +41 41 768 61 11
☎ +41 41 761 87 40

Asia/Australia

1 Pandan Crescent
Singapore 128461
☎ +65 6777 8211
☎ +65 6777 0947

Middle East/Africa

PO Box 17033
Jebel Ali Free Zone - South 2
Dubai, United Arab Emirates
☎ +971 4 811 8100
☎ +971 4 886 5465

🌐 www.emerson.com/deltav

©2017-2020, Emerson. All rights reserved.

The Emerson logo is a trademark and service mark of Emerson Electric Co. The DeltaV logo is a mark of one of the Emerson family of companies. All other marks are the property of their respective owners.

The contents of this publication are presented for informational purposes only, and while diligent efforts were made to ensure their accuracy, they are not to be construed as warranties or guarantees, express or implied, regarding the products or services described herein or their use or applicability. All sales are governed by our terms and conditions, which are available on request. We reserve the right to modify or improve the designs or specifications of our products at any time without notice.



EMERSON. CONSIDER IT SOLVED.™